

HPCIE-Q470

Half-size PICMG 1.3 CPU Card supports LGA1200 Intel® 10th/11th Gen. Core™ i9/i7/i5/i3, Pentium®, Celeron® CPU with Q470/Q470E, DDR4 SO-DIMM, HDMI™, Dual Intel® 2.5GbE, USB 3.2 Gen2, SATA 6Gb/s, M.2, IAUDIO, and RoHs

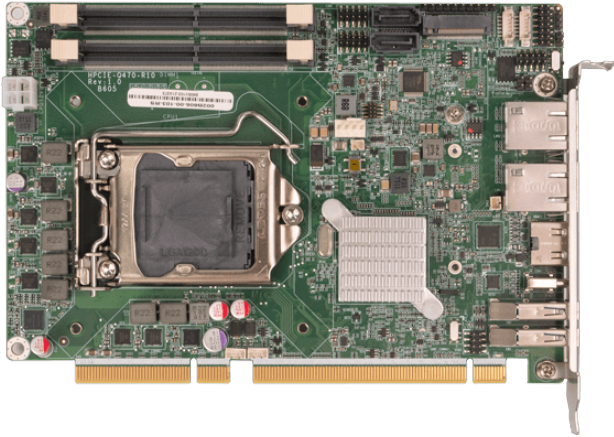

Features

1. LGA1200 Intel® 10th/11th Generation Core™ i9/i7/i5/i3, Celeron® and Pentium® processor
2. Dual-channel DDR4 2933MHz
3. Support Dual Intel® 2.5GbE
4. Support M.2 A key for WLAN expansion, M key for PCIe NVMe storage

Specifications

| | |
|-----------------------------|--|
| Form Factor | |
| Form Factor | Half Size Single Board Computer |
| System | |
| CPU | LGA1200 Intel® 10th/11th Gen. Core™ i9/i7/i5/i3, Pentium® and Celeron® processor (Support up to 65w) |
| Chipset | Intel® Q470/Q470E |
| Memory | 2 x 260-pin 2933 MHz Dual-channel DDR4 SO-DIMM, support up to 64G |
| Memory Max. | up to 64GB |
| Cooling method / System Fan | 1 x CPU fan connector (1x4 pin) |
| Physical Characteristics | |
| Dimensions (LxWxH) (mm) | 185 mm x 126 mm |
| Net Weight | 420g |
| Storage | |
| Storage | 2 x SATA : 6Gb/s (support RAID 0/1) 1 x M.2 (NGFF) : M Key (2242/2280) with PCIe Gen3 x4, support NVME storage |
| I/O Interface | |
| Display Output | 1 x HDMI™ : up to 4096 x 2160@30Hz |
| Ethernet | 2 x LAN : LAN1: Intel® I225V 2.5GbE controller LAN2: Intel® I225V 2.5GbE controller |
| Audio | 1 x HD Audio : 1 x IAUDIO, support IEI AC-KIT-888S Audio Module (2 x 5 pin) |
| I/O Interface | 2 x Internal RS-232/422/485 : 2x5 pin, P=2.00, RS-485 support AFC 2 x External USB 3.2 Gen1x1 : 5Gb/s (Type-A) 2 x Internal USB 2.0 : 2x4 pin, P=2.00 DIO : 12-bit digital I/O (2x7 pin) 1 x External USB 3.2 Gen2x1 : 10Gb/s (Type-C) |
| Expansion | 1 x PCIe x16 : signal from CPU via golden finger (supports x16, or x8 + x8, or x4 + x4 + x8) 1 x PCIe x4 : signal from PCH via golden finger (supports x4, or x1 + x1 + x1 + x1) |

| | |
|-----------------------|--|
| | 2 x M.2(NGFF) : 1 x M.2 A key (2230) with PCIe Gen3 x2/USB 2.0 1 x M.2 M key (2280/2242) with PCIe Gen3 x4 |
| Power | |
| Power Supply | 5V/12V, ATX/AT power supply |
| | Support AT/ATX mode |
| | ErP/EuP Compliant |
| Environment | |
| Operating Temperature | 0°C – 60°C |
| Storage Temperature | -30°C – 70°C |
| Humidity | 5% ~ 95%, non-condensing |
| Certifications | |
| Safety & EMC | CE/FCC compliant |

Ordering Information

| | |
|----------------|--|
| HPCIE-Q470-R10 | Half-size PICMG 1.3 CPU Card supports LGA1200 Intel® 10th Gen. Core™ i9/i7/i5/i3/Pentium®/Celeron® CPU with Q470E, DDR4 SO-DIMM, HDMI™, USB-C, Dual Intel® 2.5GbE, USB 3.2, SATA 6Gb/s, M.2, HD Audio, iAMT and RoHs |
|----------------|--|

Packing List

| | |
|--------------------------------------|----------------|
| 1 x HPCIE-Q470 single board computer | 2 x SATA cable |
| 1 x I/O shielding | 1 x QIG |

Maximizes Design Flexibility

The HPCIE-Q470 is a half-size PICMG 1.3 SBC supporting 10th/11th generation Intel® Core™, Pentium® or Celeron® processor with Intel® Q470 chipset. Aimed at customers who are seeking compact system with high computing power and flexible expansion capabilities.

With versatile IEI passive backplanes and industrial chassis options, the compact configurable system offers increased computing efficiency, flexible I/O expandability especially with PCIe x16, PCIe x8 and legacy PCI signals through backplane allowing more industrial add-on cards to satisfy the requirements of performance-demanding applications in quality defect inspection, digital surveillance, transportation and automation applications.

Spec Overview

Performance | Component Side & Solder Side

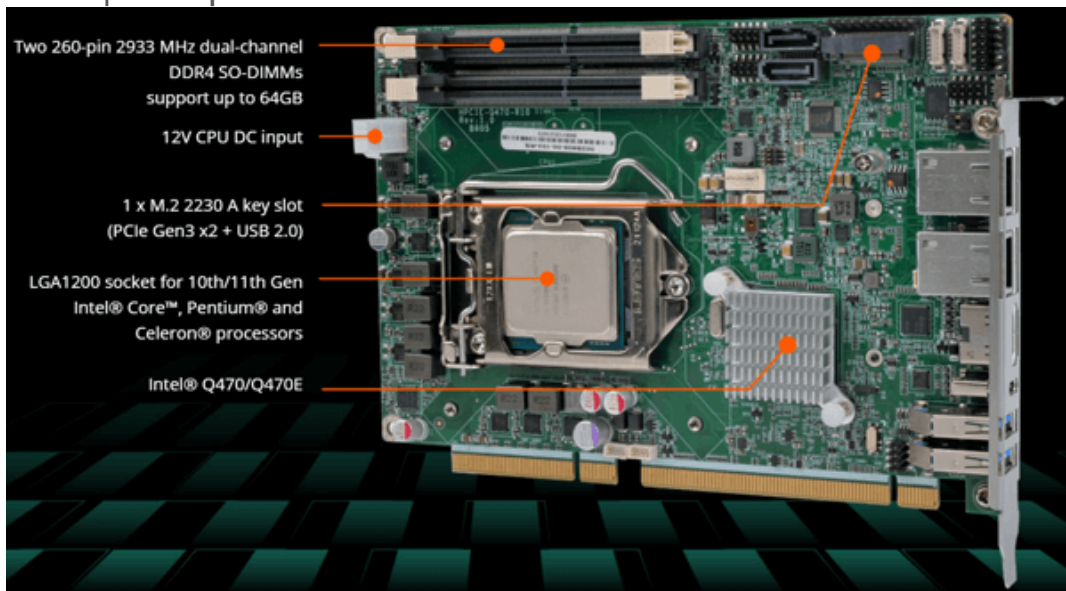

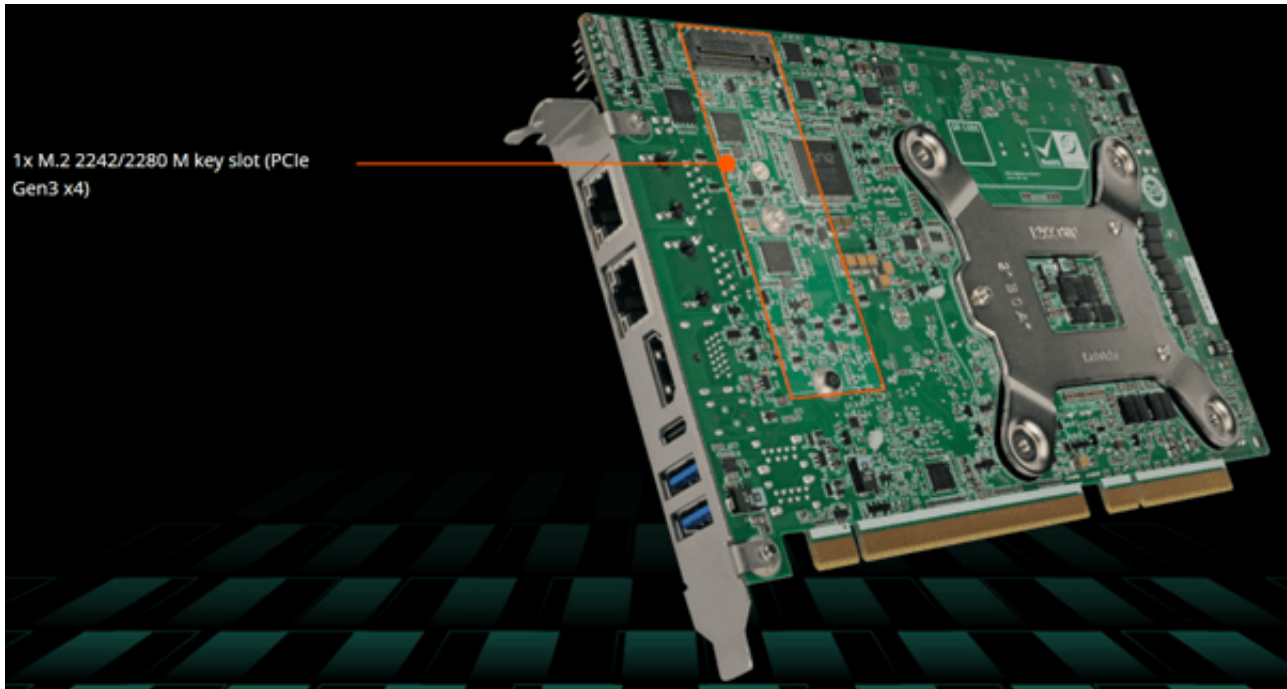

Connectivity

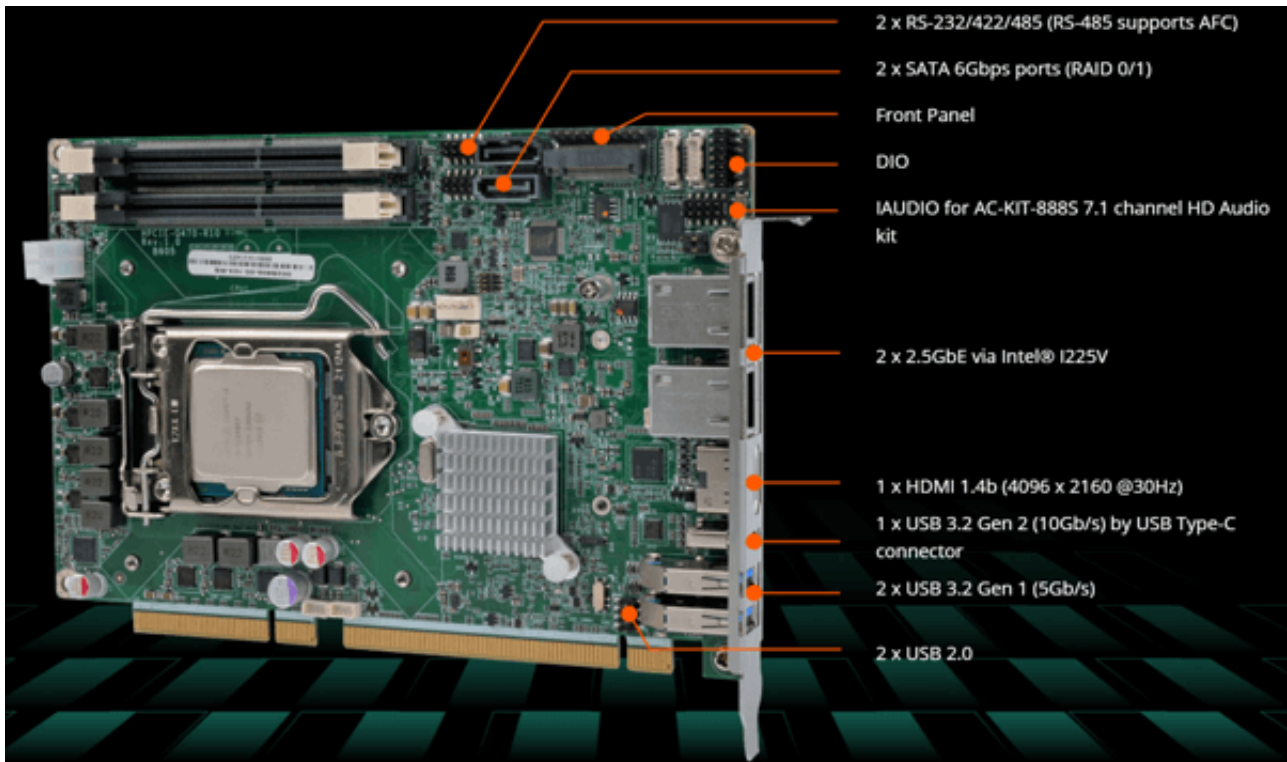

Cooling

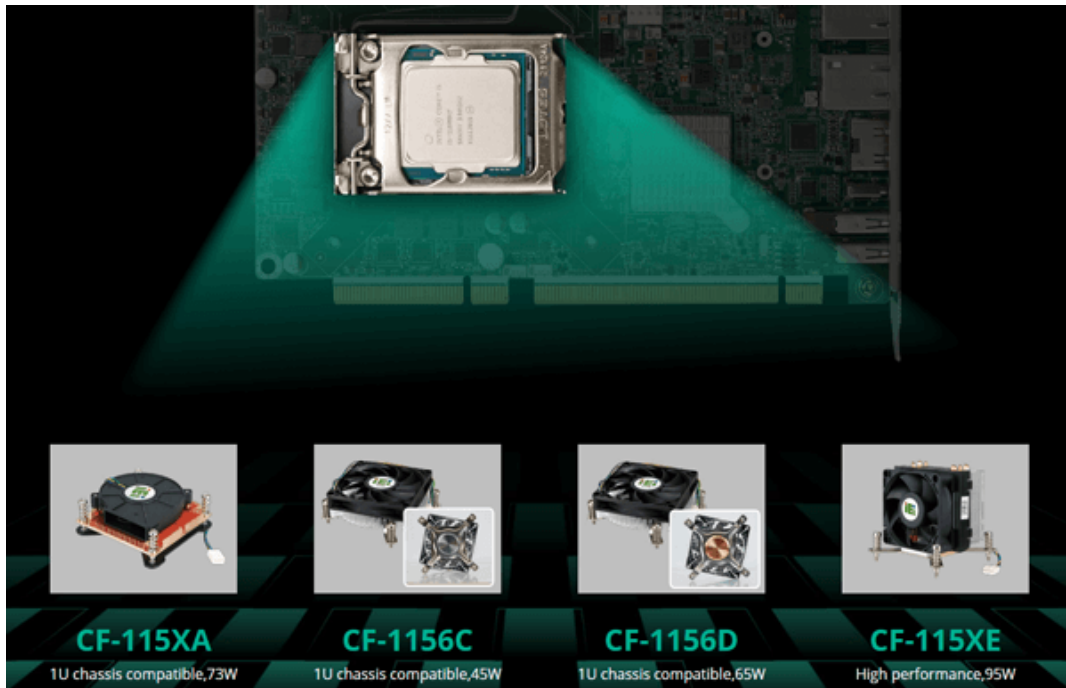

Half-size PICMG 1.3

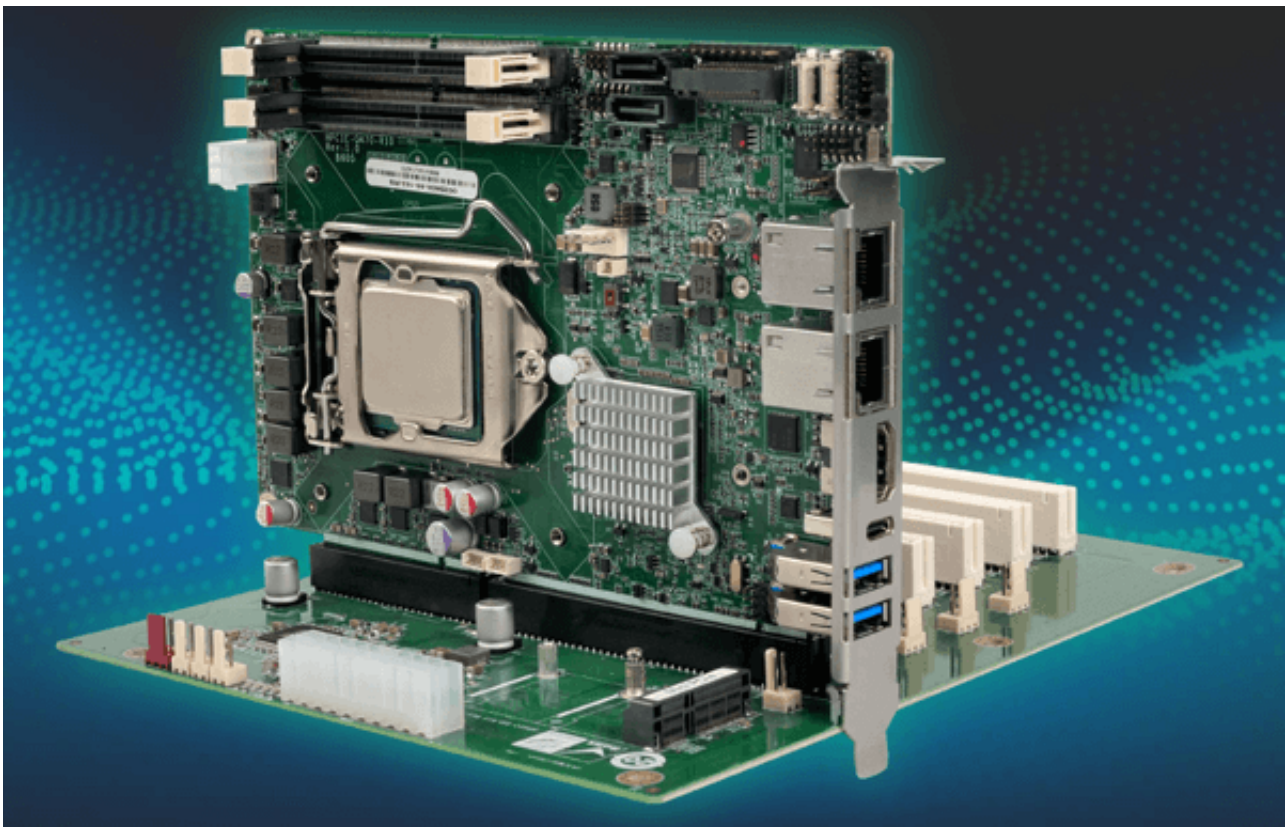

Standard PICMG 1.3 SBCs have several advantages over non-standard SBCs. Firstly, they are more maintainable than a motherboard system and have a much lower mean time to repair (MTTR). Secondly, it is easy to upgrade to a newer or faster processor if desired.

Features of PICMG 1.3:

*20 PCI Express: 20 PCI Express lanes are supported, including PCI Express x16, x8, x4 and x1 configurations

*ATX power signals are supported: Provides AUX voltages for standby power and sleep states (soft starts, wake on LAN), supports PSON#, PWRGD, PWRRBT# and ACPI states

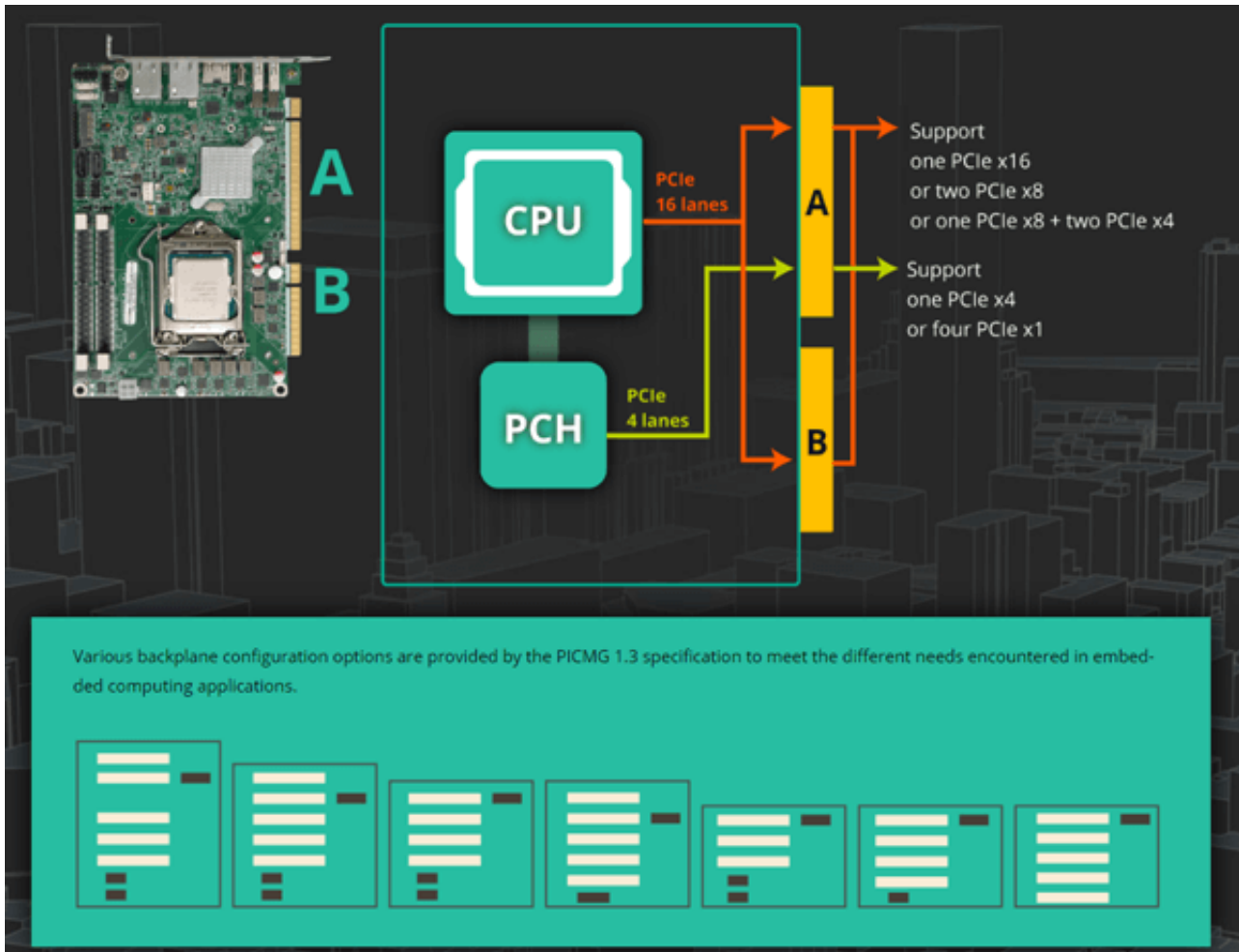

Enhanced CPU Performance

The performance boosts up to 80% better than previous generation on i5 processor. The 10th Gen Intel® Core platform supports up to 10 cores and improved performance over Coffee Lake-Refresh. With increased I/O capacity and the latest DDR4-2933 memory support, these processors deliver the performance required to consolidate industrial multiple workloads.

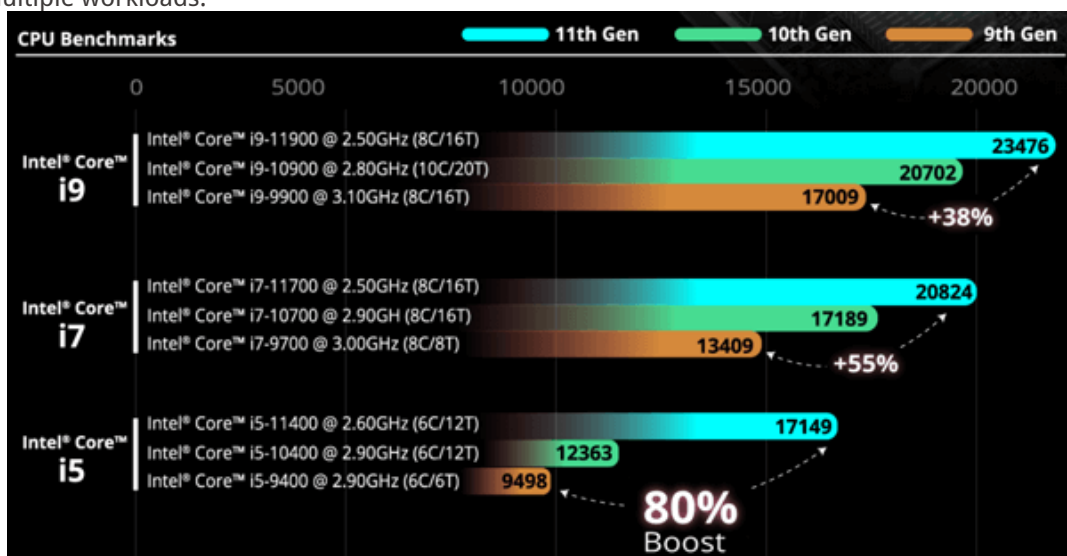

Embedded CPU Support List for 10th Gen Intel® Processors

| Sockets | Brand | Process | Cores/Threads | CPU | Processor Base Frequency | Cache | TDP | Processor Graphics | Graphics Base Frequency | Memory Types | Chipset |
|-----------|----------|-------------------|---------------|------------|--------------------------|-------|-----|-------------------------|-------------------------|--------------|------------|
| FCLGA1200 | Core™ i9 | 14nm Comet Lake-S | 10/20 | I9-10900E | 2.8 GHz | 20MB | 65W | Intel® UHD Graphics 630 | 350 MHz | DDR4-2933 | Q470/Q470E |
| | | | 10/20 | I9-10900TE | 1.8 GHz | 20MB | 35W | | | | |
| | Core™ i7 | | 8/16 | I7-10700E | 2.9 GHz | 16MB | 65W | | | | |
| | | | 8/16 | I7-10700TE | 2.0 GHz | 16MB | 35W | | | | |
| | Core™ i5 | | 6/12 | I5-10500E | 3.1 GHz | 8MB | 65W | | | | |
| | | | 6/12 | I5-10500TE | 2.3 GHz | 8MB | 35W | | | | |
| | Core™ i3 | | 4/8 | I3-10100E | 3.2 GHz | 9MB | 65W | | | | |
| | | | 4/8 | I3-10100TE | 2.3 GHz | 9MB | 35W | | | | |
| | Pentium® | | 2/4 | G6400E | 3.8 GHz | 4MB | 58W | | | | |
| | Pentium® | | 2/4 | G6400TE | 3.2 GHz | 4MB | 35W | | | | |
| | Celeron® | | 2/2 | G5900E | 3.2 GHz | 2MB | 58W | | | | |
| | Celeron® | | 2/2 | G5900TE | 3.0 GHz | 2MB | 35W | | | | |

Delivering HDMI™ 4K Resolution for Real-time Monitoring



10 Gb/s USB 3.2 Gen 2 Type-C foolproof connector

USB Type-C connectors are widely adopted by many electronic devices, such as portable SSD hard drives, smart phones, USB cameras, etc. The HPCI-E-Q470 uses the reversible connector that should end the bane of users fiddling at the back of computers.

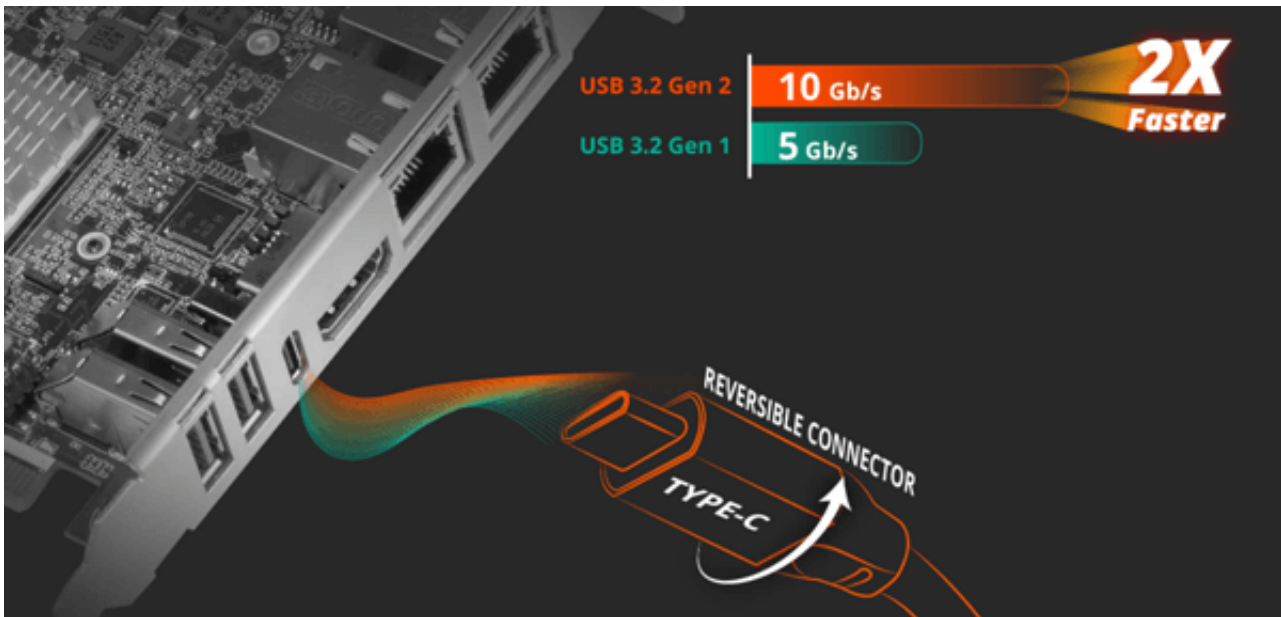

SATA 6 Gb/s Storage Performance with RAID 0/1 Protection

Protection:

- *Vibration free lockable SATA connectors and cables to protect the connection between HDD and SBC
- *RAID 1 with mirror function provides redundancy data protection

Performance:

- *RAID 0 enables faster storage performance with data striping to protect against data loss from a hard drive failure by mirroring all data across multiple devices.
- *SATA 6Gb/s is well suited for such as video editing because they require high performance to memory.

RAID 0 Speed Mode

RAID 0 mode (striping) provides higher data reading and writing performances by dividing a single file into two files and storing one on each drive.

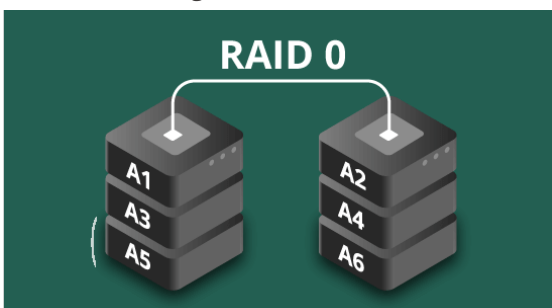

RAID 1 Safe Mode

RAID 1 mode (mirroring) backs up the identical data in both drives to prevent data loss from hard drive failure.

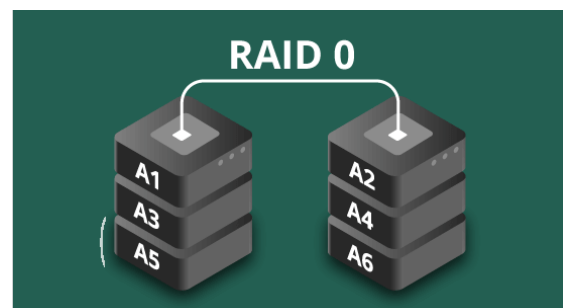

M.2 2230 A Key for Wi-Fi/Bluetooth

The M.2 2230 A key slot carrying with PCIe 3.0 x1 and USB 2.0 signals allows it to adopt the latest Wi-Fi 6E technology. Wi-Fi 6E enhances low latency and supports service levels that are equivalent to 5G networks.

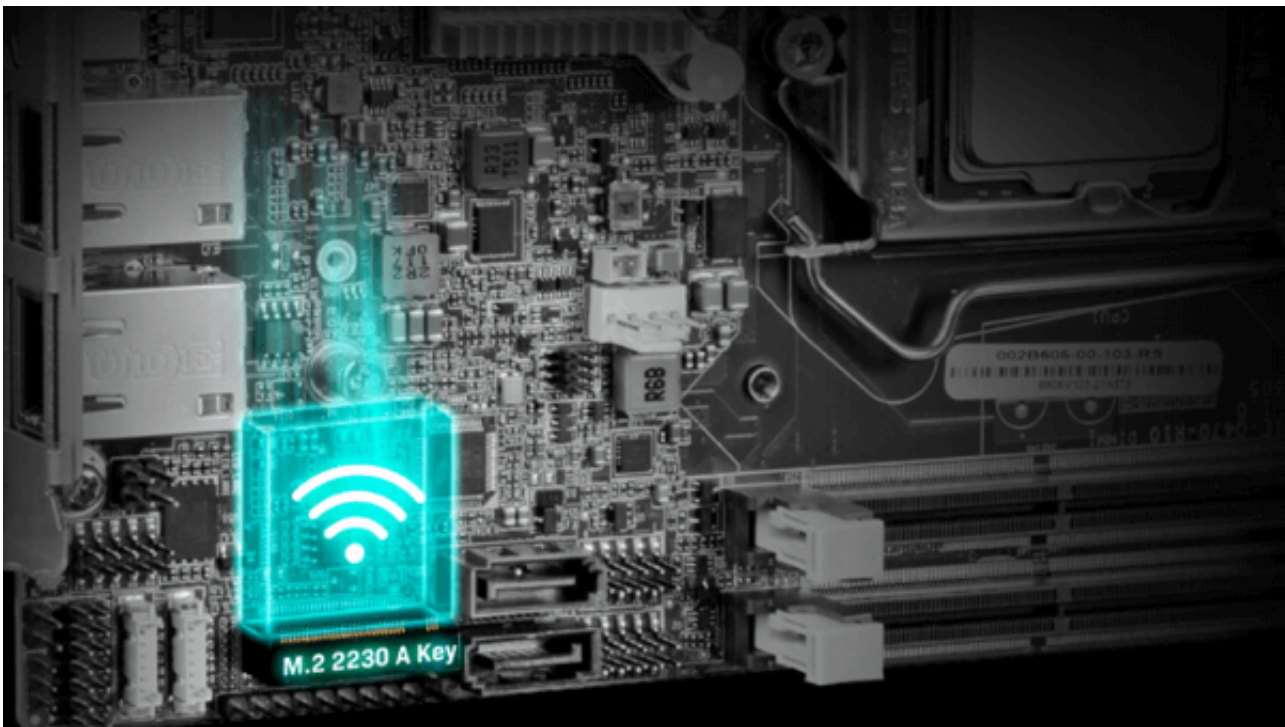

Delivering Dual Low-Latency 2.5G LAN Powered by Intel

The two on-board Intel® I225V 2.5GbE controllers enable the HPCI-E-Q470 to meet the bandwidth-intensive requirements such as large file transfers and high-resolution video streaming.

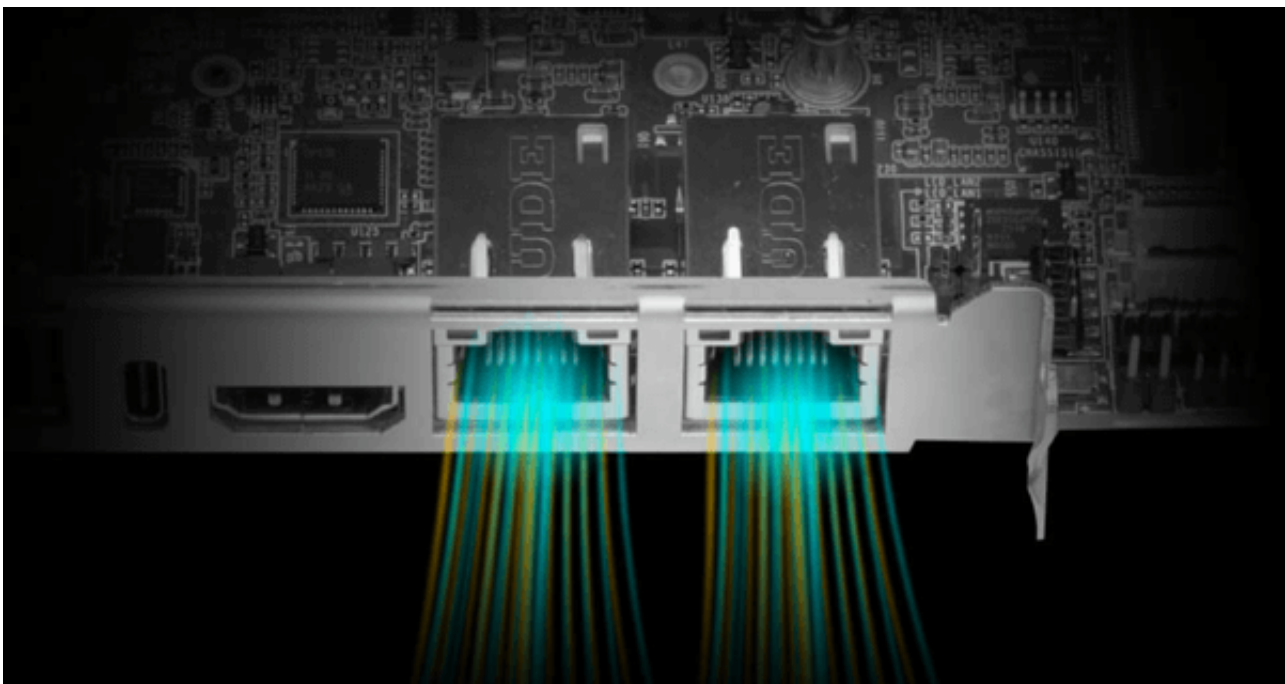

Instant System-level Solution

To suit different AIoT applications, IEI offers a comprehensive range of PICMG 1.3 passive backplanes and industrial chassis to give system designers expanded options for integrating multi-level processors within a variety of configurations.

| Industrial Chassis |  |  |  |  |
|--|---|---|--|---|
| | PR-1500G | PAC-125G | RACK-3000G | RACK-360G |
| | Wall-mount System | Wall-mount System | 4U System | 4U System |
| Dimensions (DxWxH) (mm) | 254 x 286 x 132 | 254 x 286 x 132 | 254 x 286 x 132 | 254 x 286 x 132 |
| PICMG 1.3 Half-size Backplane |  |  |  |  |
| | HPXE2-5S1 | HPXE2-8S1 | HPXE2-8S1 | HPXE2-8S1 |
| PCI | 2 | 2 | 4 | 4 |
| PCIe Gen3 x16 | 1 | | | |
| PCIe Gen3 x8 | | 4 | 2 | 2 |